

# CUTTING PLOTTER

# CG-SRIII Series

## 安全上のご注意 Safety Precautions

### 日本語

---

ご注意 .....	2
ご注意 .....	2
おねがい .....	2
電波障害自主規制 .....	2
テレビ/ラジオの受信障害について .....	2
メディアについて .....	2
安全にお使いいただくために .....	3
マーク表示について .....	3
安全ラベルについて .....	5

### For ENGLISH

---

CAUTION .....	6
CAUTION .....	6
Requests .....	6
FCC Statement (USA) .....	6
Interference to televisions and radios .....	6
Safety Precautions .....	7
Pictorial signs .....	7
Safety Labels .....	9

**Safety Precautions**

## ご注意

株式会社ミマキエンジニアリングの保証規定に定めるものを除き、本製品の使用または使用不能から生ずるいかなる損害（逸失利益、間接損害、特別損害またはその他の金銭的損害を含み、これらに限定しない）に関して一切の責任を負わないものとします。

また、株式会社ミマキエンジニアリングに損害の可能性について知らされていた場合も同様とします。

一例として、本製品を使用してシート等の損失やシートを使用して作成された物によって生じた間接的な損失等の責任負担もしないものとします。

本装置を使用したことによる金銭上の損害および逸失利益または第三者からのいかなる請求についても、当社は一切その責任を負いかねますので、あらかじめご了承ください。

## おねがい

- この取扱説明書は、内容について十分注意しておりますが、万一ご不審な点などがありましたら、販売店または弊社営業所までご連絡ください。
- この取扱説明書は、改良のため予告なく変更する場合があります。
- 本書記載の名称は、一般に各社の商標または登録商標です。

## 電波障害自主規制

この装置は、クラス A 情報技術装置です。この装置を家庭で使用すると電波妨害を引き起こすことがあります。この場合には使用者が適切な対策を講ずるよう要求されることがあります。

VCCI-A

## テレビ/ラジオの受信障害について

本書が解説する製品は、使用時に高周波が発生します。このため、この製品が不適切な条件下で設置または使用された場合、ラジオやテレビの受信障害が発生する可能性があります。したがって、特殊なラジオ/テレビに対しては保証しておりません。

もしも、この製品がラジオ/テレビ受信の障害原因と思われれば、この製品の電源を切ることによりご確認いただけます。電源を切ることにより受信障害が解消されればこの製品が原因と考えられます。

もし障害の原因なら、次の手順のいずれか、あるいはいくつかを組み合わせでお試してください。

- テレビやラジオのアンテナの向きを変え、受信障害の発生しない位置をさがしてください。
- この製品から離れた場所にテレビやラジオを設置してください。
- この製品とは別の電源供給路にあるコンセントにテレビやラジオを接続してください。

## メディアについて









ご不要になりましたロール紙やメディアは、地域の条例に従って処分してください。

# 安全にお使いいただくために





## マーク表示について

本書では、マーク表示により操作上の注意内容を説明しています。注意内容により表示するマークは異なります。各マーク表示の持つ意味をご理解し、本装置を安全に正しくお使いください。





### マーク表示の例





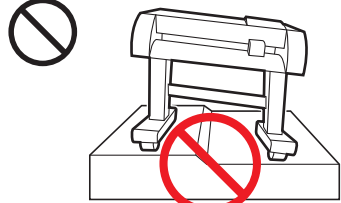

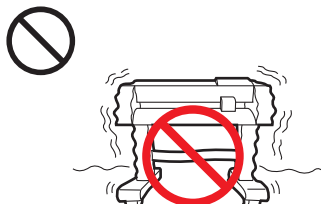
内 容	
	「警告」マークは、指示を無視して誤った取り扱いをすると、人が死亡または重傷を負う可能性が想定される内容を示しています。必ずよくお読みになり、正しくお使いください。
	「注意」マークは、指示を無視して誤った取り扱いをすると、人が傷害を負う可能性が想定される内容および物的損害の発生が想定される内容を示しています。
	「重要」マークは、本装置をお使いいただく上で、知っておいていただきたい内容が書かれています。操作の参考にしてください。
	「ヒント」マークは、知っておくと便利なことが書かれています。操作の参考にしてください。
	関連した内容の参照ページを示しています。
	△マークは、注意（危険・警告を含む）を促す内容があることを告げるものです。中に具体的な注意事項（左図の場合は感電注意）が描かれています。
	⊘記号は、禁止の行為であることを告げるものです。図の中や近傍に具体的な禁止内容（左図の場合は分解禁止）が描かれています。
	●記号は、行為を強制したり、指示する内容を告げるものです。図の中に具体的な指示内容（左図の場合は差し込みプラグをコンセントから抜いてください）が描かれています。

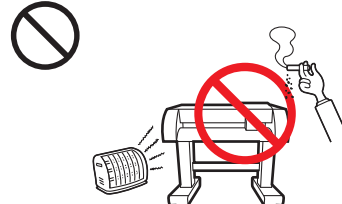
## ⚠ 警告

<p><b>分解・改造はしない</b></p> <p> 本装置の分解・改造は、絶対にしないでください。感電や故障の原因になります。</p>	<p><b>電源ケーブルの取り扱い</b></p> <p> 付属の電源ケーブルを使用してください。 電源ケーブルを傷つけたり、破損したり、加工しないでください。また、重い物をのせたり、加熱したり、ひっばったりすると電源ケーブルが破損し、火災・感電の原因になります。</p>
<p><b>湿気の多い場所では使用しない</b></p> <p> 湿気の多い場所の使用や、装置に水をかけないでください。火災や感電、故障の原因になります。</p>	<p><b>異常事態の発生</b></p> <p> 万一、煙が出ている、変な臭いがするなどの異常事態のまま使用すると、火災・感電の原因になります。すぐに、電源スイッチをオフにして、その後必ずプラグをコンセントから抜いてください。煙が出なくなるのを確認してから、販売店または弊社営業所に修理をご依頼ください。 お客様による修理は危険ですから絶対におやめください。</p>

## ⚠ 注意

<p><b>直射日光が当たる場所</b></p> <p></p>	<p><b>水平でない場所</b></p> <p></p>	<p><b>温度や湿度の変化が激しい場所</b></p> <p> 次の環境下でお使いください。 動作環境： 5 ~ 35 °C 35 ~ 75 % (Rh)</p>
<p><b>振動が発生する場所</b></p> <p></p>	<p><b>エアコンなどの風が直接当たる場所</b></p> <p></p>	<p><b>火を使う場所</b></p> <p></p>

 注 意	
<b>可動部分に注意</b>  <ul style="list-style-type: none"> <li>回転中のグリットローラには触れないでください。指の皮や爪をはいでけがをする場合があります。</li> </ul>	<b>カッターについて</b>  <ul style="list-style-type: none"> <li>カッターの刃先は鋭利です。触らないでください。</li> <li>カッターホルダーは振らないでください。刃先が飛び出す場合があります。</li> </ul>
 <ul style="list-style-type: none"> <li>カット（作図）中は、可動部分に顔や手を近づけないでください。髪の毛を巻き込んだり、けがをする場合があります。</li> </ul>	<b>電源ケーブルの接続について</b>  <ul style="list-style-type: none"> <li>必ずアース接続をしてください。アースを接続しないでご使用になると、本装置の破損や感電の原因となることがあり、大変危険です。</li> <li>2極のコンセントを使用する場合は、電源ケーブルのプラグに付属の接地アダプタを接続します。接地アダプタの緑色の線（アース線）をアース処理してください。アース処理できない場合は、電気工事店にご相談ください。</li> </ul>
 <ul style="list-style-type: none"> <li>作業の妨げになるような服装（ダブついた服装、装飾品など）で作業しないでください。また、長い髪の毛は束ねてください。</li> </ul>	
<b>シートについて</b>	
 <ul style="list-style-type: none"> <li>カールのきついシートは、カールを取り除いてから使用してください。カールがきついと、カット（作図）に影響を及ぼします。</li> </ul>	

## 安全ラベルについて

本装置には、安全ラベルが貼ってあります。安全ラベルの内容を十分理解してください。安全ラベルが汚れて読めなくなったり、剥がれた場合は、新しい安全ラベルを販売店または弊社営業所にてお買い求めください。（注文 No.M904451）製造時期によりラベルが異なります。再注文する場合は M904451 を注文してください。

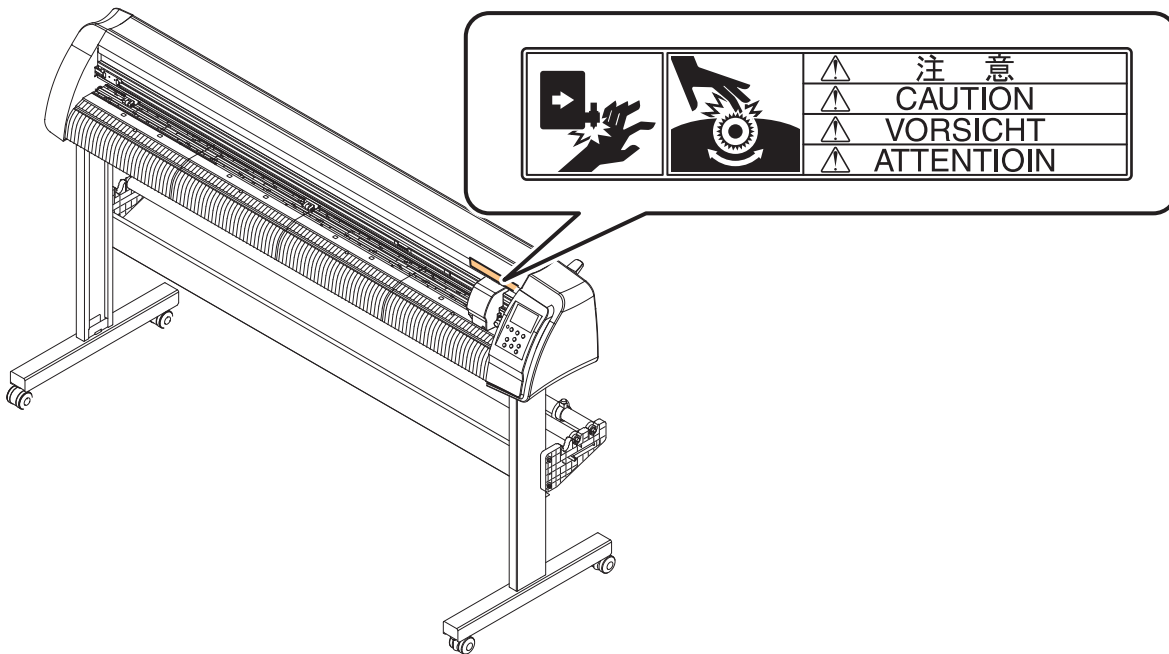

## CAUTION

DISCLAIMER OF WARRANTY : THIS LIMITED WARRANTY OF MIMAKI SHALL BE THE SOLE AND EXCLUSIVE WARRANTY AND IS IN LIEU OF ALL OTHER WARRANTIES, EXPRESS OR IMPLIED, INCLUDING, BUT NOT LIMITED TO, ANY IMPLIED WARRANTY OF MERCHANTABILITY OR FITNESS, AND MIMAKI NEITHER ASSUMES NOR AUTHORIZES DEALER TO ASSUME FOR IT ANY OTHER OBLIGATION OR LIABILITY OR MAKE ANY OTHER WARRANTY OR MAKE ANY OTHER WARRANTY IN CONNECTION WITH ANY PRODUCT WITHOUT MIMAKI'S PRIOR WRITTEN CONSENT. IN NO EVENT SHALL MIMAKI BE LIABLE FOR SPECIAL, INCIDENTAL OR CONSEQUENTIAL DAMAGES OR FOR LOSS OF PROFITS OF DEALER OR CUSTOMERS OF ANY PRODUCT.

## Requests

- This Operation manual has been carefully prepared for your easy understanding. However, please do not hesitate to contact a distributor in your district or our office if you have any inquiry.
- Description contained in this Operation manual are subject to change without notice for improvement.
- Generally, names and designations referred to in this Operation manual are trade marks or registered trade marks of the manufacturers or suppliers.

## FCC Statement (USA)

This equipment has been tested and found to comply with the limits for a Class A digital device, pursuant to Part 15 of the FCC Rules. These limits are designed to provide reasonable protection against harmful interference when the equipment is operated in a commercial environment. This equipment generates, uses and can radiate radio frequency energy and, if not installed and used in accordance with the Operation manual, may cause harmful interference to radio communications. Operation of this equipment in a residential area is likely to cause harmful interference in which case the user will be required to correct the interference at his own expense.



- In the case where MIMAKI-recommended cable is not used for connection of this device, limits provided by FCC rules can be exceeded. To prevent this, use of MIMAKI-recommended cable is essential for the connection of this plotter.

## Interference to televisions and radios

The product described in this manual generates high frequency when operating.

The product can interfere with radios and televisions if set up or commissioned under improper conditions. The product is not guaranteed against any damage to specific-purpose radio and televisions.

The product's interference with your radio or television will be checked by turning on/off the power switch of the product.

In the event that the product is the cause of interference, try to eliminate it by taking one of the following corrective measures or taking some of them in combination.











- Change the orientation of the antenna of the television set or radio to find a position without reception difficulty.
- Separate the television set or radio from this product.
- Plug the power cord of this product into an outlet which is isolated from power circuits connected to the television set or radio.

# Safety Precautions

## Pictorial signs





Pictorial signs are used in this Operation manual for safe operation and for prevention of damage to the plotter. Pictorial signs and their meanings are given below. Read and fully understand before reading the text.

### Examples of symbols

Meaning	
	Failure to observe the instructions given with this symbol can result in death or serious injuries to personnel. Be sure to read and observe the instructions for proper operation.
	Failure to observe the instructions given with this symbol can result in injuries to personnel or damage to property.
	This symbol indicates that the information is helpful in proper operation of the plotter..
	This symbol indicates that it is important to know of the information on proper operation of the plotter. Use this information for your operation.
	Indicates the reference page for related contents.
	The symbol "  " indicates that the instructions must be observed as strictly as the CAUTION instructions (including DANGER and WARNING instructions). A sign representing a precaution (the sign shown at left warns of hazardous voltage) is shown in the triangle.
	The symbol "  " indicates that the action shown is prohibited. A sign representing a prohibited action (the sign shown at left prohibits disassembly) is shown in or around the circle.
	The symbol "  " indicates that the action shown must be taken without fail or the instructions must be observed without fail. A sign representing a particular instruction (the sign shown at left instructs to unplug the cable from the wall outlet) is shown in the circle.





## WARNING





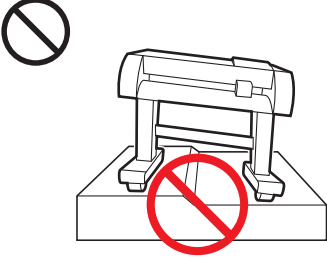

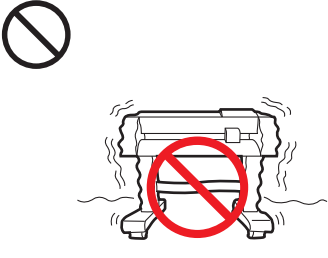
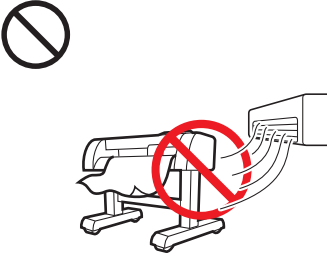
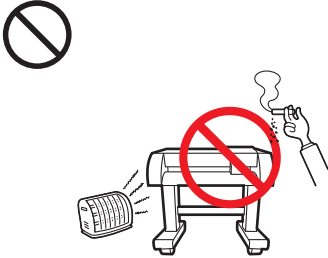
<p><b>Do not disassemble or remodel the plotter.</b></p>  <ul style="list-style-type: none"> <li>• Never disassemble or remodel the plotter. Disassembly or remodeling can result in an electric shock or breakdown of the machine.</li> </ul>	<p><b>Handling of the power cable</b></p>  <ul style="list-style-type: none"> <li>• Use the supplied power cable. Take care not to damage, break or work upon the power cable. If a heavy material is placed on the power cable, or if it is heated or pulled, the power cable can break, thus resulting in fire or electric shocks.</li> </ul>
<p><b>Avoid locating the plotter in a damp environment.</b></p>  <ul style="list-style-type: none"> <li>• Do not use the plotter in a damp place. Do not splash water onto the machine. Use in such an environment can give rise to fire, electric shocks or breakdown of the plotter.</li> </ul>	<p><b>In case abnormal event occurs.</b></p>  <ul style="list-style-type: none"> <li>• Use of the plotter under an abnormal condition where the device produces smoke or strange smell can result in fire or electric shocks. If such an abnormality is found, be sure to turn off the power switch immediately and unplug the cable from the wall outlet. Check first that the plotter no longer produces smoke, and contact your distributor for repair.</li> <li>• Never repair your plotter by yourself since it is very dangerous for you to do so.</li> </ul>



## CAUTION

<p><b>A place exposed to direct sunlight</b></p> 	<p><b>On an inclined surface</b></p> 	<p><b>A place where temperature or humidity varies significantly</b></p>  <ul style="list-style-type: none"> <li>• Use the plotter under the following environmental conditions:</li> <li>• Operating environment: 5 to 35°C 35 to 75% (Rh)</li> </ul>
<p><b>A place that vibrates</b></p> 	<p><b>A place exposed to direct air flow from an air conditioner or the like.</b></p> 	<p><b>Around a place where fire is used</b></p> 



 <b>CAUTION</b>	
<p><b>Be careful with the movable parts</b></p> <ul style="list-style-type: none"> <li> Do not touch the rolling grit roller; otherwise, you may hurt your fingers or tear off your finger nails.</li> <li> Keep your head and hands away from any moving parts during cutting (plotting) operation; otherwise, you may get your hair caught in the machine or get injuries.</li> <li> Wear proper clothes. (Do not wear loose-fit clothes or accessories). Bind a long hair.</li> </ul>	<p><b>Caution with cutters</b></p> <ul style="list-style-type: none"> <li> Do not touch the cutter blade, which is very sharp.</li> <li>Do not shake or swing the cutter holder; otherwise, the blade may come off.</li> </ul>
<p><b>Sheets</b></p> <ul style="list-style-type: none"> <li> Straighten the sheet of media, if significantly curled, before using it for printing. Heavily curled sheet affects the cutting (plotting) result.</li> </ul>	<p><b>Connection of power supply cable</b></p> <ul style="list-style-type: none"> <li> Be sure to connect the ground wire. Using without the ground wire causes the damage of this device and electric shock that may be very dangerous.</li> <li>Regarding the use of two polar plug outlet, you must connect the auxiliary ground adapter to the plug of power cable. Earth the green wire (ground wire) of the ground adapter. If you cannot, consult with an electrician.</li> </ul>

## Safety Labels

A safety label is stuck on the machine. The label informs the user of possible risks associated with the machine.

Be sure to understand the correct meaning of the safety label to avoid danger.

If the safety label is illegible due to stains or has come off, purchase a new one from your local distributor or our office. (Reorder: No.M904451, Safety label)

Depending on the manufacturing time, the label differs. When reordering the label, please ask for M904451 as a order number.

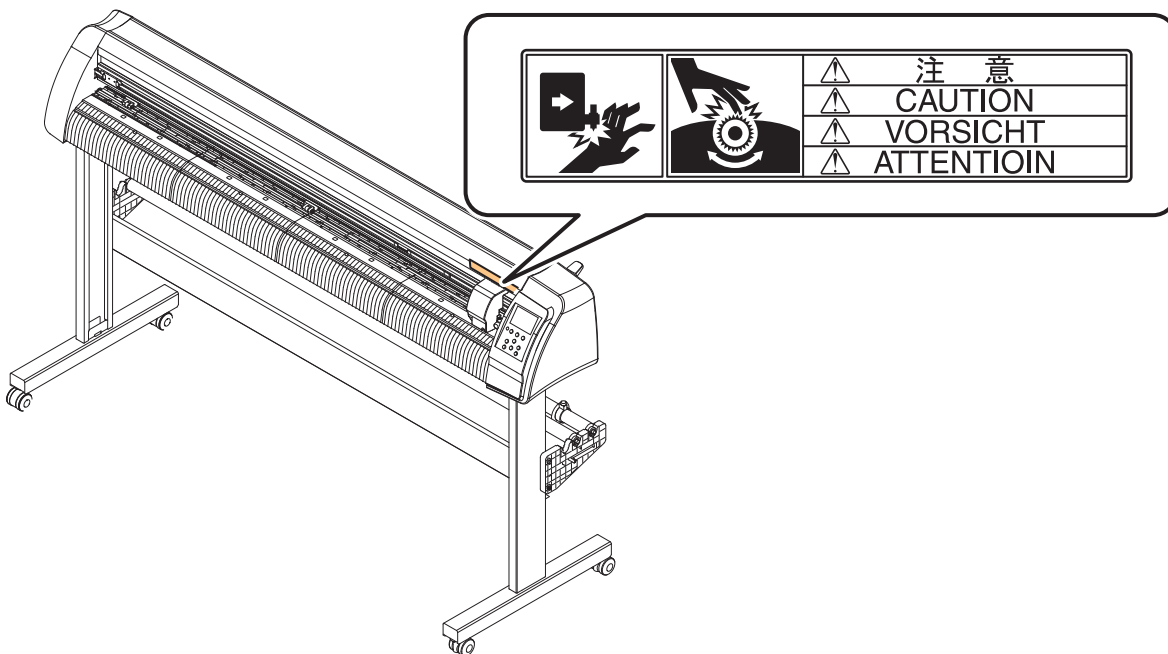



# **EC DECLARATION OF CONFORMITY**

We hereby declare that the following our product conforms with the essential health and safety requirements of EC Directives.

Product	CUTTING PLOTTER
Model No.	CG-60SRIII(SGPL767) CG-100SRIII(SGPL767) CG-130SRIII(SG-PL767)
Manufacturer	MIMAKI ENGINEERING CO.,LTD. 2182-3, Shigeno-otsu, Tomi, Nagano, 389-0512, JAPAN
Authorised Compiler in the Community	MIMAKI EUROPE B.V. Stammerdijk 7E 1112 AA Diemen, The Netherlands
Directives	Machinery Directive 2006/42/EC Low Voltage Directive 2006/95/EC EMC Directive 2004/108/EC

The above product has been evaluated for conformity with above directives using the following European standards. The technical construction file (TCF) for this product is retained at the above Manufacturer's location.

Machinery Directive / Low Voltage Directive	EN ISO12100:2010, EN60204-1:2006+A1:2009, EN60950-1:2006+A11+A1
EMC Directive	EN55022:2006+A1:2007, EN61000-3-2:2006+A1+A2, EN61000-3-3:2008, EN55024:1998+A1:2001+A2:2003

